



TIEMME

CASSETTA COLLETTORI PREMONTATA PŘEDMONTOVANÁ SESTAVA ROZVADĚČE

Art. 3033/3035

Collettori lineari compatti forniti montati in cassetta completi di rosoni e cappucci cromati con rubinetti di arresto a vitone.

Kompletní sada rozdělovače předmontovaná v plastové skříni, obsahující rozety, chromové krytky a uzavírací ventily.

La coppia di collettori di distribuzione Art.3033 è generalmente utilizzata nelle reti di distribuzione di acqua calda e fredda. Sono costituiti da 6 vie fredde e 4 vie calde con uscite dallo stesso lato. Qualora nell'installazione risultassero vie in eccesso basta intercettarle con i tappi in dotazione. Grazie alla loro configurazione permettono l'alimentazione in parallelo delle utenze per acqua calda e/o fredda riducendo al minimo le perdite di carico.

I collettori sono prodotti in conformità alle normative in materia e sono certificati relativamente alla composizione chimica dei materiali impiegati ed a livello dimensionale.

Rozdělovače SANIBOX art. TM3033 (TM3035) se obvykle používají pro rozvod teplé a studené vody. Tyto rozdělovače disponují 6 odběrnými místy pro studenou vodu a 4 odběrnými místy pro teplou vodu směřující na stejnou stranu. Nevyužitě vývody mohou být uzavřeny přiloženými zátkami. Díky své konstrukci mohou být tyto rozdělovače použity k distribuci studené/teplé vody a zároveň ke snížení tlakových ztrát na minimum. Tyto rozdělovače jsou vyráběny v souladu s příslušnými normami a jsou certifikovány z hlediska všech materiálových (chemických) i rozměrových požadavků.



Certificazioni/Certifikace

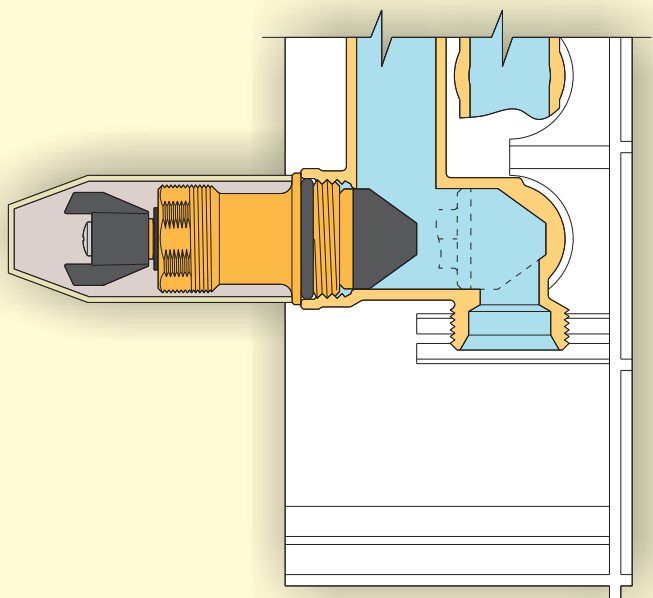

Caratteristiche Tecniche

Temperatura max di esercizio: 110°C
Temperatura min di esercizio: -20°C(*)
Pressione max di esercizio: 10 bar
Filettature: maschio 3/4" ISO 228 (cilindrica)
maschio 24X19 fil. (cilindrica)

Technické specifikace

Maximální teplota: 110°C
Minimální teplota: -20°C(*)
Maximální provozní tlak: 10 barů
Závity: vnější 3/4" ISO 228 (paralelní)
vnější 24x19 fil. (paralelní)

Descrizione	Materiale	Trattamento
Corpi collettore	Ottone CW617N - EN12165	Cromato
Vitoni	Ottone CW617N - EN12164	-
O-rings	Gomma nitrilica NBR	-
Guarnizioni	Gomma nitrilica NBR	-
Cappucci	Ottone CW617N - EN12164	Lucidato/Cromato
Rosoni	Ottone CW617N - EN12164	Lucidato/Cromato
Cassetta	ABS bianco	-

Popis	Materiál	Povrchová úprava
Tělo	Mosaz CW617N-EN12165	Chrom
Šroub	Mosaz CW617N-EN12164	-
O-kroužky	Nitrilová pryž NBR	-
Těsnění	Nitrilová pryž NBR	-
Koncovky	Mosaz CW617N-EN12164	Leštění / chrom
Rozety	Mosaz CW617N-EN12164	Leštění / chrom
Skříň (box)	Bílý ABS	-

(*) za předpokladu, že kapalina zůstane v kapalném skupenství

TIEMME Raccorderie S.p.A. si riserva di apportare modifiche in qualsiasi momento senza preavviso.
TIEMME Raccorderie S.p.A. reserves the right to modify contents in any time without prior advise.
È vietata qualsiasi forma di riproduzione, se non autorizzata.
Any form of unauthorized reproduction is banned.



TIEMME Raccorderie S.p.A.
Via Cavallera 6/A (Loc. Barco) - 25045 Castegnato (Bs) - Italy
Tel +39 030 2142211 R.A. - Fax +39 030 2142206
info@tiemme.com - www.tiemme.com





TIEMME

CASSETTA COLLETTORI PREMONTATA PŘEDMONTOVANÁ SESTAVA ROZVADĚČE

Art. 3033/3035

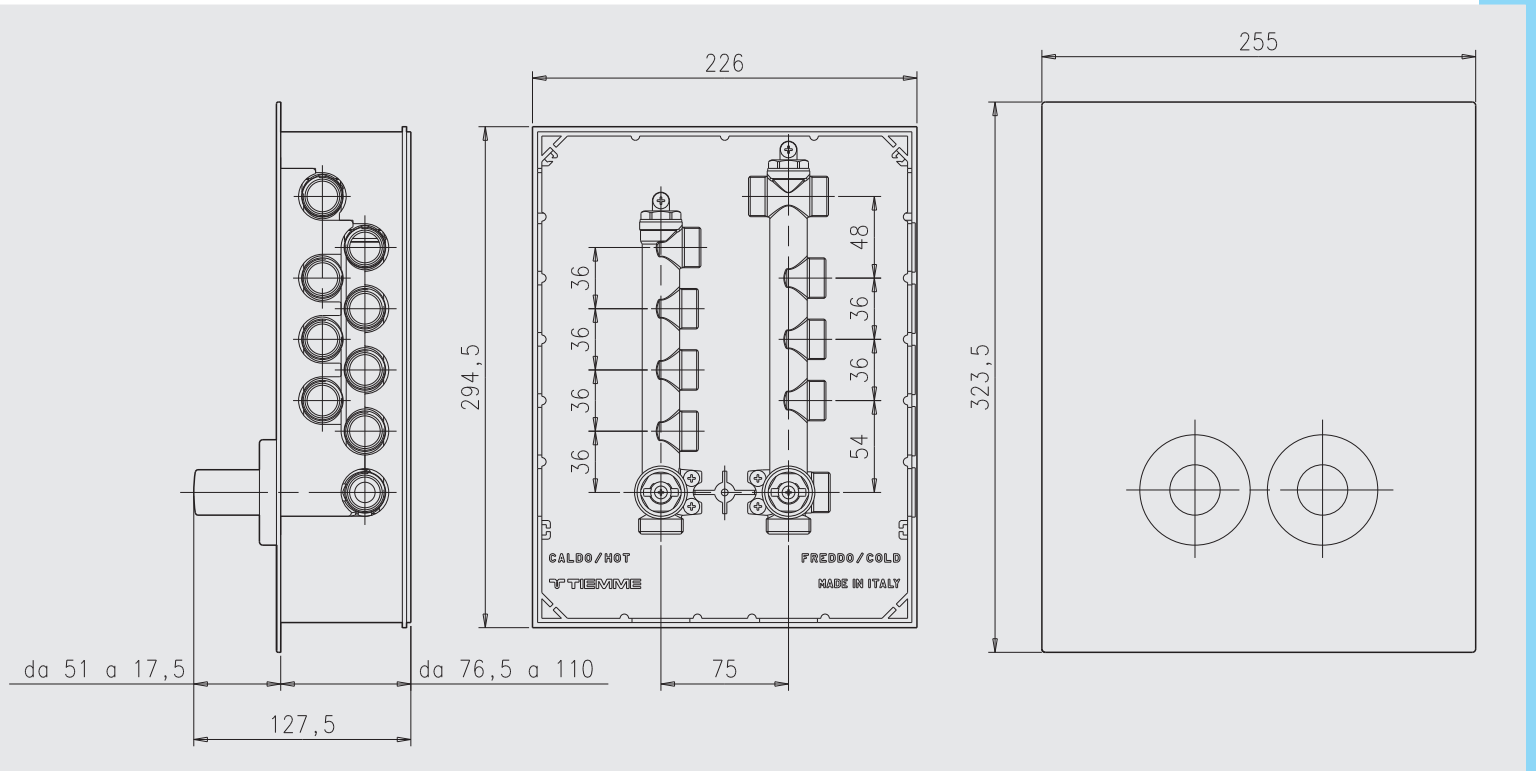

Esempi di installazione / Příklad instalace

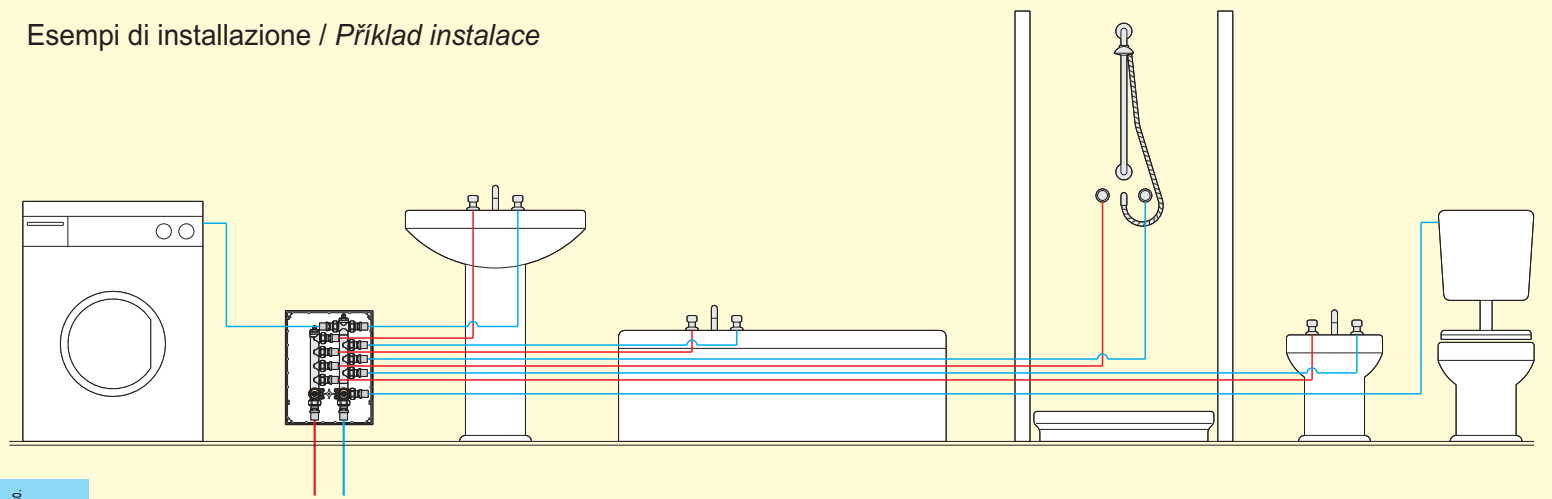

TIEMME Raccorderie S.p.A. si riserva di apportare modifiche in qualsiasi momento senza preavviso.
 TIEMME Raccorderie S.p.A. reserves the right to modify contents freely, time without prior advice.
 E veľeta quľasik forma reprodukcij, se non autorizzata.
 Any form of unauthorized reproduction is banned.

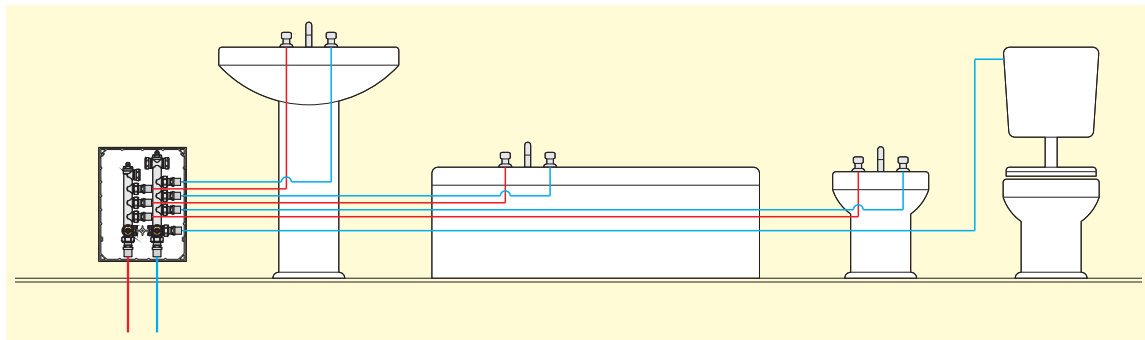

TIEMME Raccorderie S.p.A.
 Via Cavallera 6/A (Loc. Barco) - 25045 Castegnato (Bs) - Italy
 Tel +39 030 2142211 R.A. - Fax +39 030 2142206
 info@tiemme.com - www.tiemme.com





TIEMME

CASSETTA COLLETTORI PREMONTATA PŘEDMONTOVANÁ SESTAVA ROZVADĚČE

Art. 3033/3035

Guida alle connessioni Průvodce připojením

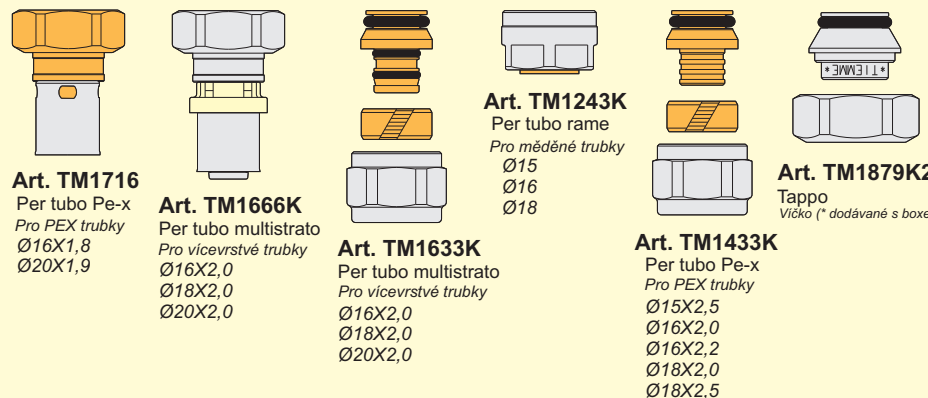
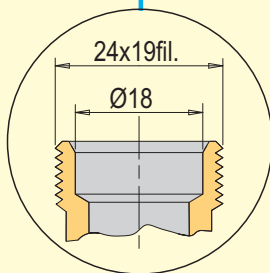
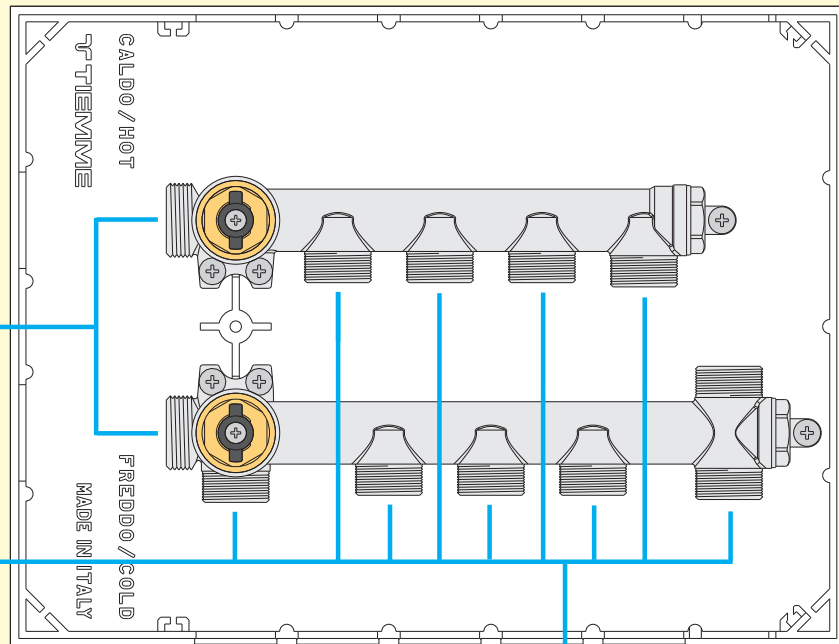
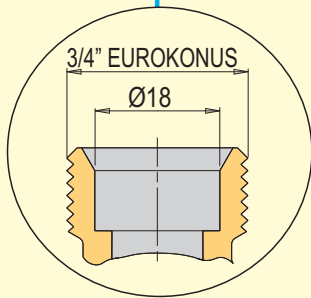
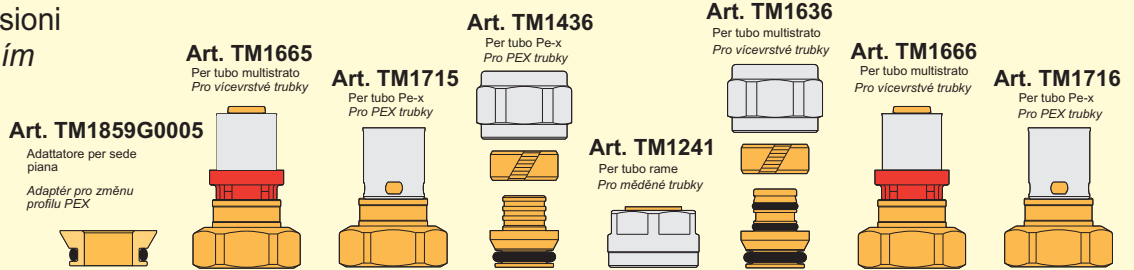

TIEMME Raccorderie S.p.A. si riserva di apportare modifiche in qualsiasi momento senza preavviso.
TIEMME Raccorderie S.p.A. reserves the right to modify contents in any time without prior advise.
È vietata qualsiasi forma di riproduzione, se non autorizzata.
Any form of unauthorized reproduction is banned.



TIEMME Raccorderie S.p.A.
Via Cavallera 6/A (Loc. Barco) - 25045 Castegnato (Bs) - Italy
Tel +39 030 2142211 R.A. - Fax +39 030 2142206
info@tiemme.com - www.tiemme.com

